

EHF1325ETTS-13.300M-CC

[Click part number to visit Part Number Details page](#)

REGULATORY COMPLIANCE (Data Sheet downloaded on Nov 13, 2019)

[Click badges to download compliance docs](#)

Regulatory Compliance standards are subject to updates by governing bodies. Click the badges to download the latest compliance docs for this part number directly from Ecliptek.



ITEM DESCRIPTION

Quartz Crystal Clock Oscillators XO (SPXO) LVCMOS (CMOS) 3.3Vdc 14 Pin DIP Metal Thru-Hole 13.300MHz ± 25 ppm -40°C to +85°C

ELECTRICAL SPECIFICATIONS

Nominal Frequency	13.300MHz
Frequency Tolerance/Stability	± 25 ppm Maximum (Inclusive of all conditions: Calibration Tolerance at 25°C, Frequency Stability over the Operating Temperature Range, Supply Voltage Change, Output Load Change, Output Load Change, First Year Aging at 25°C, Shock, and Vibration)
Aging at 25°C	± 5 ppm/year Maximum
Operating Temperature Range	-40°C to +85°C
Supply Voltage	3.3Vdc $\pm 10\%$
Input Current	35mA Maximum (No Load)
Output Voltage Logic High (Voh)	2.7Vdc Minimum (IOH = -8mA)
Output Voltage Logic Low (Vol)	0.5Vdc Maximum (IOL = +8mA)
Rise/Fall Time	6nSec Maximum (Measured at 20% to 80% of waveform)
Duty Cycle	50 ± 10 (%) (Measured at 50% of waveform)
Load Drive Capability	30pF Maximum
Output Logic Type	CMOS
Pin 1 Connection	Tri-State (Disabled Output: High Impedance)
Tri-State Input Voltage (Vih and Vil)	70% of Vdd Minimum to Enable Output, 20% of Vdd Maximum to Disable Output, No Connect to Enable Output.
Absolute Clock Jitter	± 250 pSec Maximum, ± 100 pSec Typical
One Sigma Clock Period Jitter	± 50 pSec Maximum, ± 40 pSec Typical
Start Up Time	10mSec Maximum
Storage Temperature Range	-55°C to +125°C

ENVIRONMENTAL & MECHANICAL SPECIFICATIONS

Fine Leak Test	MIL-STD-883, Method 1014, Condition A
Gross Leak Test	MIL-STD-883, Method 1014, Condition C
Lead Integrity	MIL-STD-883, Method 2004
Mechanical Shock	MIL-STD-202, Method 213, Condition C
Resistance to Soldering Heat	MIL-STD-202, Method 210
Resistance to Solvents	MIL-STD-202, Method 215
Solderability	MIL-STD-883, Method 2003
Temperature Cycling	MIL-STD-883, Method 1010
Vibration	MIL-STD-883, Method 2007, Condition A

EHF1325ETTS-13.300M-CC [Click part number to visit Part Number Details page](#)

MECHANICAL DIMENSIONS (all dimensions in millimeters)

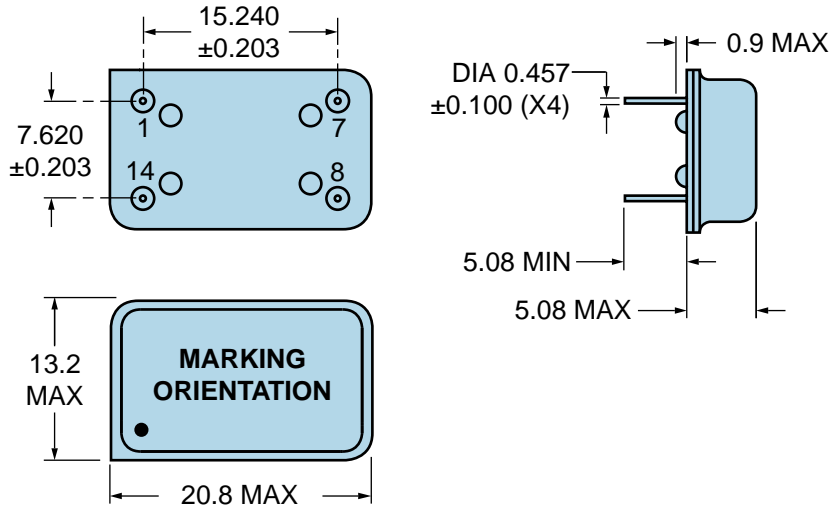

PIN	CONNECTION
1	Tri-State (High Impedance)
7	Ground/Case Ground
8	Output
14	Supply Voltage

LINE	MARKING
1	ECLIPTEK
2	13.300M
3	XXXXX XXXXX=Ecliptek Manufacturing Identifier

EHF1325ETTS-13.300M-CC [Click part number to visit Part Number Details page](#)

OUTPUT WAVEFORM & TIMING DIAGRAM



EHF1325ETTS-13.300M-CC

[Click part number to visit Part Number Details page](#)

Test Circuit for CMOS Output



Note 1: An external 0.01µF ceramic bypass capacitor in parallel with a 0.1µF high frequency ceramic bypass capacitor close (less than 2mm) to the package ground and supply voltage pin is required.

Note 2: A low capacitance (<12pF), 10X attenuation factor, high impedance (>10Mohms), and high bandwidth (>300MHz) passive probe is recommended.

Note 3: Capacitance value C_L includes sum of all probe and fixture capacitance.

Value Added Option - Cut Leads

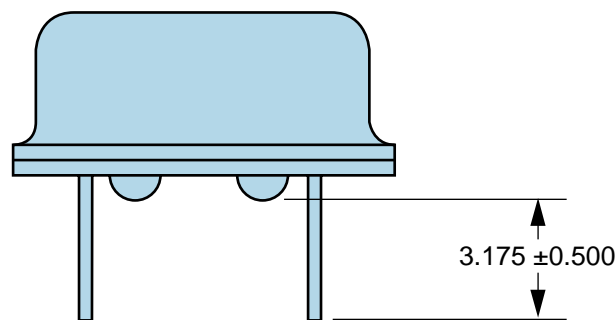

All dimensions are in millimeters

EHF1325ETTS-13.300M-CC [Click part number to visit Part Number Details page](#)

Recommended Solder Reflow Methods



High Temperature Solder Bath (Wave Solder)

Ts MAX to TL (Ramp-up Rate)	3°C/Second Maximum
Preheat	
- Temperature Minimum (Ts MIN)	150°C
- Temperature Typical (Ts TYP)	175°C
- Temperature Maximum (Ts MAX)	200°C
- Time (ts MIN)	60 - 180 Seconds
Ramp-up Rate (TL to TP)	3°C/Second Maximum
Time Maintained Above:	
- Temperature (TL)	217°C
- Time (tL)	60 - 150 Seconds
Peak Temperature (TP)	260°C Maximum for 10 Seconds Maximum
Target Peak Temperature (TP Target)	250°C +0/-5°C
Time within 5°C of actual peak (tp)	20 - 40 Seconds
Ramp-down Rate	6°C/Second Maximum
Time 25°C to Peak Temperature (t)	8 Minutes Maximum
Moisture Sensitivity Level	Level 1
Additional Notes	Temperatures shown are applied to back of PCB board and device leads only. Do not use this method for product with the Gull Wing option.

EHF1325ETTS-13.300M-CC [Click part number to visit Part Number Details page](#)

Recommended Solder Reflow Methods



Low Temperature Infrared/Convection 185°C

Ts MAX to Tl (Ramp-up Rate)	5°C/Second Maximum
Preheat	
- Temperature Minimum (Ts MIN)	N/A
- Temperature Typical (Ts TYP)	150°C
- Temperature Maximum (Ts MAX)	N/A
- Time (ts MIN)	60 - 120 Seconds
Ramp-up Rate (Tl to Tp)	5°C/Second Maximum
Time Maintained Above:	
- Temperature (Tl)	150°C
- Time (tL)	200 Seconds Maximum
Peak Temperature (Tp)	185°C Maximum
Target Peak Temperature (Tp Target)	185°C Maximum 2 Times
Time within 5°C of actual peak (tp)	10 Seconds Maximum 2 Times
Ramp-down Rate	5°C/Second Maximum
Time 25°C to Peak Temperature (t)	N/A
Moisture Sensitivity Level	Level 1
Additional Notes	Temperatures shown are applied to body of device. Use this method only for product with the Gull Wing option.

EHF1325ETTS-13.300M-CC

[Click part number to visit Part Number Details page](#)

Recommended Solder Reflow Methods



Low Temperature Solder Bath (Wave Solder)

Ts MAX to TL (Ramp-up Rate)	5°C/Second Maximum
Preheat	
- Temperature Minimum (Ts MIN)	N/A
- Temperature Typical (Ts TYP)	150°C
- Temperature Maximum (Ts MAX)	N/A
- Time (ts MIN)	30 - 60 Seconds
Ramp-up Rate (TL to TP)	5°C/Second Maximum
Time Maintained Above:	
- Temperature (TL)	150°C
- Time (tL)	200 Seconds Maximum
Peak Temperature (TP)	245°C Maximum
Target Peak Temperature (TP Target)	245°C Maximum 1 Time / 235°C Maximum 2 Times
Time within 5°C of actual peak (tp)	5 Seconds Maximum 1 Time / 15 Seconds Maximum 2 Times
Ramp-down Rate	5°C/Second Maximum
Time 25°C to Peak Temperature (t)	N/A
Moisture Sensitivity Level	Level 1
Additional Notes	Temperatures shown are applied to back of PCB board and device leads only. Do not use this method for product with the Gull Wing option.

Low Temperature Manual Soldering

185°C Maximum for 10 Seconds Maximum, 2 times Maximum. (Temperatures listed are applied to device leads only. This method can be utilized with both Gull Wing and Non-Gull Wing devices.)

High Temperature Manual Soldering

260°C Maximum for 5 Seconds Maximum, 2 times Maximum. (Temperatures listed are applied to device leads only. This method can be utilized with both Gull Wing and Non-Gull Wing devices.)