

EMS23HHF-12.500M

[Click part number to visit Part Number Details page](#)

REGULATORY COMPLIANCE (Data Sheet downloaded on Jan 17, 2020)



◀ Click badges to download compliance docs

Regulatory Compliance standards are subject to updates by governing bodies. Click the badges to download the latest compliance docs for this part number directly from Ecliptek.



ITEM DESCRIPTION

Spread Spectrum MEMS Clock Oscillators LVCMOS (CMOS) 3.3Vdc 4 Pad 3.2mm x 5.0mm Plastic Surface Mount (SMD) 12.500MHz ±50ppm Maximum over -40°C to +85°C Tri-State -2.00% Down Spread

ELECTRICAL SPECIFICATIONS

Nominal Frequency	12.500MHz
Frequency Tolerance/Stability	±50ppm Maximum over -40°C to +85°C (Inclusive of all conditions: Calibration Tolerance at 25°C, Frequency Stability over the Operating Temperature Range, Supply Voltage Change, Output Load Change, First Year Aging at 25°C, 260°C Reflow, Shock, and Vibration)
Aging at 25°C	±1ppm Maximum First Year
Supply Voltage	3.3Vdc ±10%
Maximum Supply Voltage	-0.5Vdc to +3.65Vdc
Input Current	30mA Maximum (Unloaded; Nominal Vdd)
Output Voltage Logic High (Voh)	90% of Vdd Minimum (IOH=-8mA)
Output Voltage Logic Low (Vol)	10% of Vdd Maximum (IOL=+8mA)
Rise/Fall Time	2nSec Maximum (Measured from 20% to 80% of waveform)
Duty Cycle	50 ±5(%) (Measured at 50% of waveform)
Load Drive Capability	15pF Maximum
Output Logic Type	CMOS
Output Control Function	Tri-State (Disabled Output High Impedance)
Tri-State Input Voltage (Vih and Vil)	70% of Vdd Minimum or No Connection to Enable Output, 30% of Vdd Maximum to Disable Output
Disable Current	20mA Maximum (Disabled Output: High Impedance) (Pad 1=Ground)
Spread Spectrum	-2.00% Down Spread
Modulation Frequency	30kHz Minimum, 32kHz Typical, 35kHz Maximum
Period Jitter	30pSec Maximum (Cycle to Cycle; Spread Spectrum-On; Fo=133.333M, Vdd=3.3Vdc)
Start Up Time	10mSec Maximum
Storage Temperature Range	-55°C to +125°C

ENVIRONMENTAL & MECHANICAL SPECIFICATIONS

ESD Susceptibility	MIL-STD-883, Method 3015, Class 2, HBM 2000V
Flammability	UL94-V0
Mechanical Shock	MIL-STD-883, Method 2002, Condition G, 30,000G
Moisture Resistance	MIL-STD-883, Method 1004
Moisture Sensitivity Level	J-STD-020, MSL 1
Resistance to Soldering Heat	MIL-STD-202, Method 210, Condition K
Resistance to Solvents	MIL-STD-202, Method 215
Solderability	MIL-STD-883, Method 2003 (Pads on bottom of package only)
Temperature Cycling	MIL-STD-883, Method 1010, Condition B
Thermal Shock	MIL-STD-883, Method 1011, Condition B
Vibration	MIL-STD-883, Method 2007, Condition A, 20G

EMS23HHF-12.500M [Click part number to visit Part Number Details page](#)

MECHANICAL DIMENSIONS (all dimensions in millimeters)



PIN	CONNECTION
1	Tri-State (High Impedance)
2	Ground
3	Output
4	Supply Voltage

LINE	MARKING
1	XXXX or XXXXX XXXX or XXXXX=Ecliptek Manufacturing Identifier

Suggested Solder Pad Layout

All Dimensions in Millimeters



All Tolerances are ± 0.1

EMS23HHF-12.500M [Click part number to visit Part Number Details page](#)

OUTPUT WAVEFORM & TIMING DIAGRAM



EMS23HHF-12.500M

[Click part number to visit Part Number Details page](#)

Test Circuit for CMOS Output

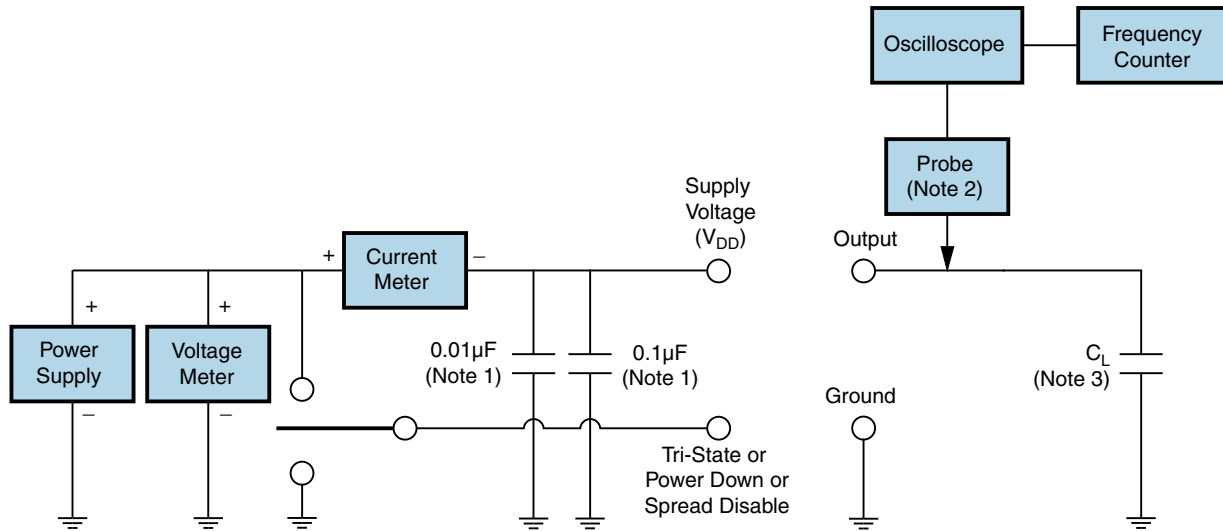

Note 1: An external 0.01µF ceramic bypass capacitor in parallel with a 0.1µF high frequency ceramic bypass capacitor close (less than 2mm) to the package ground and supply voltage pin is required.

Note 2: A low capacitance (<12pF), 10X attenuation factor, high impedance (>10Mohms), and high bandwidth (>300MHz) passive probe is recommended.

Note 3: Capacitance value C_L includes sum of all probe and fixture capacitance.

EMS23HHF-12.500M

[Click part number to visit Part Number Details page](#)

Recommended Solder Reflow Methods



High Temperature Infrared/Convection

Ts MAX to Tl (Ramp-up Rate)	3°C/Second Maximum
Preheat	
- Temperature Minimum (Ts MIN)	150°C
- Temperature Typical (Ts TYP)	175°C
- Temperature Maximum (Ts MAX)	200°C
- Time (ts MIN)	60 - 180 Seconds
Ramp-up Rate (Tl to Tp)	3°C/Second Maximum
Time Maintained Above:	
- Temperature (Tl)	217°C
- Time (tL)	60 - 150 Seconds
Peak Temperature (Tp)	260°C Maximum for 10 Seconds Maximum
Target Peak Temperature (Tp Target)	250°C +0/-5°C
Time within 5°C of actual peak (tp)	20 - 40 Seconds
Ramp-down Rate	6°C/Second Maximum
Time 25°C to Peak Temperature (t)	8 Minutes Maximum
Moisture Sensitivity Level	Level 1
Additional Notes	Temperatures shown are applied to body of device.

EMS23HHF-12.500M [Click part number to visit Part Number Details page](#)

Recommended Solder Reflow Methods



Low Temperature Infrared/Convection 240°C

T_s MAX to T_L (Ramp-up Rate)	5°C/Second Maximum
Preheat	
- Temperature Minimum (T_s MIN)	N/A
- Temperature Typical (T_s TYP)	150°C
- Temperature Maximum (T_s MAX)	N/A
- Time (t_s MIN)	60 - 120 Seconds
Ramp-up Rate (T_L to T_P)	5°C/Second Maximum
Time Maintained Above:	
- Temperature (T_L)	150°C
- Time (t_L)	200 Seconds Maximum
Peak Temperature (T_P)	240°C Maximum
Target Peak Temperature (T_P Target)	240°C Maximum 2 Times / 230°C Maximum 1 Time
Time within 5°C of actual peak (t_p)	10 Seconds Maximum 2 Times / 80 Seconds Maximum 1 Time
Ramp-down Rate	5°C/Second Maximum
Time 25°C to Peak Temperature (t)	N/A
Moisture Sensitivity Level	Level 1
Additional Notes	Temperatures shown are applied to body of device.

Low Temperature Manual Soldering

185°C Maximum for 10 Seconds Maximum, 2 times Maximum. (Temperatures shown are applied to body of device.)

High Temperature Manual Soldering

260°C Maximum for 5 Seconds Maximum, 2 times Maximum. (Temperatures shown are applied to body of device.)