

Frequently Asked Questions

Rev A

For Series:	EMRA45
-------------	--------

1. What is this oscillator series?

This series of devices are oscillators where the output frequency is primarily controlled by an internal micro-electro-mechanical system (MEMS) resonator and an integrated complementary metal-oxide semiconductor (CMOS) circuit. Utilizing a proprietary MEMS resonator design and exclusive processing methods, this oscillator series is calibrated to a specified frequency prior to shipment to the customer.

2. What are the typical customer circuit applications for this oscillator series?

This oscillator series can be used in any of the following applications:

- Clock Recovery
- Phase-Locked Loop and Frequency Synthesis
- Synthesizer or System Reference
- Clock Distribution
- Clock Translation and Multiplexing

3. What are the typical applications and end item products for this series?

Here is a list of the common applications and products:

- PCI Express
- Gigabit Ethernet
- Fiber Channel
- SATA/SAS
- FBDIMM, DDR, SONET, ATM, SDH
- Routers, Servers, Hubs, and Network Switches
- High Resolution Video and Set-top Boxes
- Scanners, Printers, Modems
- LCD Displays and HDTV
- Interface Controllers
- Medical Equipment
- PDAs and Portable Media Players
- Digital Cameras and Gaming Products
- Notebook Computers

- Video Cameras and Video Recorders
- Portable Devices
- Computer Peripherals and Networking Products

4. What technical benefits does this product series offer?

This series of MEMS oscillator offers:

- Tight frequency stability
- Wide operating temperature ranges available
- Tight duty cycle option of 50% \pm 5%
- Tri-state (High impedance) and Power Down (Logic low) output options
- Low Voltage CMOS output with controlled rise and fall times
- Low rms period jitter
- Four pad moisture sensitivity level 1 (MSL1) rated plastic SMD package
- RoHS Compliant (Pb-free) with high temperature 260°C reflow capability

5. What are the construction characteristics of this product series?

This product series consists of a single CMOS application specific integrated circuit (ASIC) and a MEMS resonator die stacked inside an industry standard QFN-type plastic injection molded package. This assembly configuration results in superior thermal performance, high reliability, and low lead inductance. The termination I/O pads consist of Ni/Pd/Au metallization.

6. What is the input supply voltage for this product series?

The nominal supply voltage and tolerance is provided on the datasheet.

7. What are the input current specifications for this product series?

The input current specification is listed in milliamps as a maximum value and is provided on the datasheet.

8. What are the frequency stability and operating temperature range options for this product series?

The available operating temperature range and frequency stability options can be found on the datasheet.

9. Does this series offer a power down output control option?

This product series offers a power down output control option for power management. If the power down option is selected, all active circuitry within the oscillator is shut down when the voltage at the control pad (pad one) is set to a logic low state. In this condition, the output pad (pad three) is forced to a logic low and the input current on the power supply line is negligible. The stand-by current specification can be found on the data sheet. Note: The oscillator has an internal pull up resistor on the control pad. The series datasheet provides the V_{IH} and V_{IL} thresholds for control of the power down function.

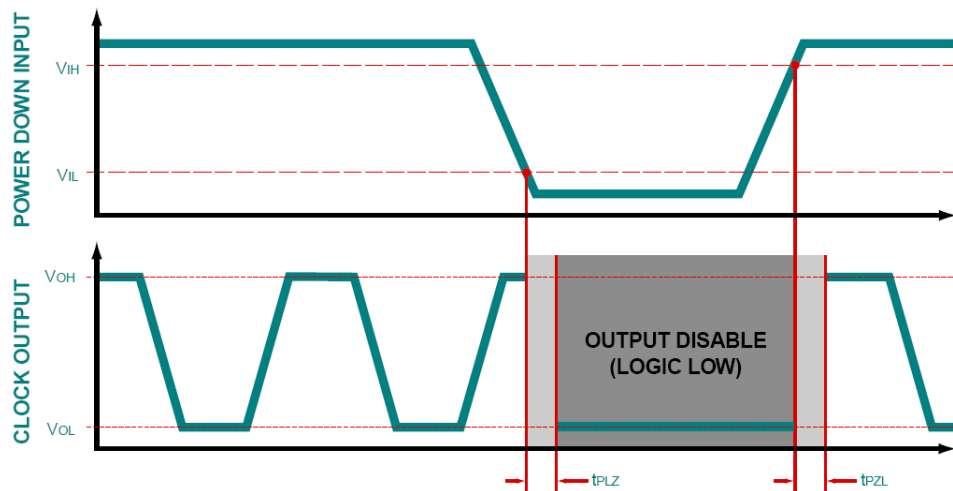

When entering the power down mode, the time from when the oscillator pad one input control reaches V_{IL} and the oscillator output pad becomes logic low is shown as t_{PLZ} . When exiting the power down mode, the time from when the oscillator pad one input control reaches V_{OH} and the oscillator output begins clocking is shown as t_{PZL} . The oscillator power down disable (t_{PLZ}) and enable time (t_{PZL}) specifications are listed on the datasheet.

10. Does this series offer a tri-state output control option?

This product series offers a tri-state output control option for power management. If the tri-state option is selected, the output is three-stated (tri- state) when the voltage at the control pad (pad one) is set to a logic low state. In this condition, the internal oscillator circuit continues to operate. However, the output pad (pad three) is now high impedance and the input current on the power supply line is only slightly decreased from normal operating current. Note: The oscillator has an internal pull up resistor on the control pad. The series datasheet provides the V_{IH} and V_{IL} thresholds for control of the tri-state function.

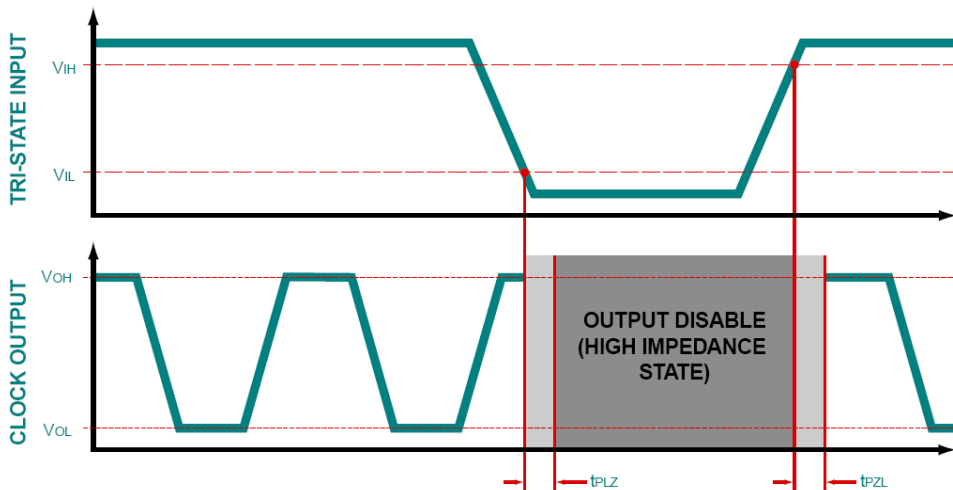

Figure: Tri-State Timing Diagram

When entering the tri-state mode, the time from when the oscillator pad one input control reaches V_{IL} and the oscillator output pad becomes high impedance is shown as t_{PLZ} . When exiting the tri-state mode, the time from when the oscillator pad one input control reaches V_{OH} and the oscillator output begins clocking is shown as t_{PZL} . The oscillator tri-state disable (t_{PLZ}) and enable time (t_{PZL}) specifications are listed on the datasheet.

11. Can I obtain a non-tri-state or non-power down function for this product series?

This product series only offers the tri-state or power down options on pad one of the oscillator. The customer can use this oscillator series as a non-tri-state or non-power down oscillator by setting the voltage on the control pad (pad one) to either no connect or logic high. The oscillator has an internal pull up resistor on control pad (pad one). The datasheet provides the V_{IH} and V_{IL} thresholds for control of the tri-state or power down functions.

12. How do I specify the overall frequency stability for this product series?

Ecliptek defines the frequency stability performance of the device inclusive of specific oscillator operating conditions. This is often called the "Inclusive Method". Ecliptek specifies the following parameters for this series of product:

- Calibration Frequency Tolerance at 25°C
- Frequency Stability over Operating Temperature Range
- Supply Voltage
- Output Load

13. What is oscillator aging and what are the aging specifications for this product series?

Aging is the systematic change in frequency with time due to internal changes in the MEMS and/or oscillator. Aging is often expressed as a maximum value in parts per million per year [ppm/year]. The following factors effect oscillator aging: adsorption and desorption of contamination on the surfaces of the MEMS resonator, stress relief of the mounting and bonding structures, material outgassing, and seal integrity. The aging specification can be found on the datasheet.

14. What is phase noise and what is the rms phase jitter specification for this product series?

Phase noise is a measure in the frequency domain and is specified in decibels at various offset points from the carrier (-dBc/Hz). Phase jitter, (often called offset jitter) is derived from the phase noise measurement of the spectral density over a given offset bandwidth. Ecliptek uses a proprietary design, exclusive processing methods and a unique ASIC output driver circuit enabling this product series to have exceptionally low phase jitter. The rms phase jitter specification can be found on the datasheet.

15. What is the rms period jitter performance for this product series?

Period jitter is a time domain measurement and is specified in picoseconds (pSec) as a maximum value. Ecliptek uses a proprietary design, exclusive processing methods and a unique ASIC output driver circuit enabling this product series to have low period jitter. The rms period jitter specification can be found on the datasheet.

16. What is duty cycle and what is the duty cycle specification for this product series?

Duty cycle is the measure of output waveform uniformity. This term, also referred to as symmetry, is a measurement of the time that the output waveform is in a logic high state, expressed as a percentage (%) of the clock period. This parameter is measured at a specified voltage threshold or at a percentage of the output

waveform amplitude. See the datasheet for measurement thresholds and load conditions. The duty cycle specification can be found on the datasheet.

17. What are the output and output load characteristics for this product series?

Ecliptek offers this product series with a low voltage CMOS driver that enables the output signal to swing from ground to V_{DD} . The oscillator output topology is designed so as to optimize circuit load matching and signal performance. Signal integrity is optimized when the low impedance output of the oscillator is driving a high impedance-low capacitance input. The output load specification is listed on the datasheet.

18. Is start-up time specified for this product series?

As shown in the figure below, start-up time is defined as the time (t_0) from when the power supply reaches its specified V_{IH} value (90% of V_{DD}) to the time (t_1) the oscillator output signal amplitude reaches its steady state V_{OH} output logic high level and the output is within the specified frequency tolerance. The start-up time specification can be found on the datasheet.

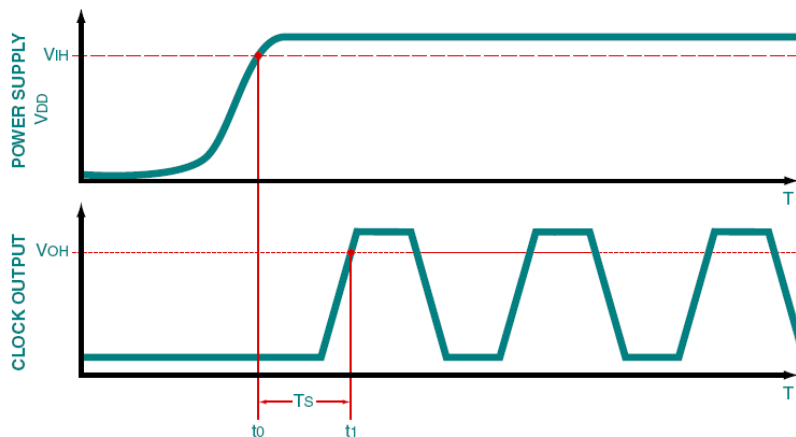

Figure: Oscillator Start-up Timing Diagram

19. How do I electrically test this product series at my facility?

The recommended electrical test fixture can be found on the datasheet.

20. Is this product series compatible with my existing assembly process equipment?

If the part number is specified with the TR packaging option, oscillator products are delivered to the customer in EIA481 compliant tape and reel packaging. Without the TR option, products are delivered to the customer in bulk packaging as specified on the datasheet.

21. Is this product series compatible with my existing reflow processes?

This product series is capable of withstanding industry standard high temperature (260°C, 10 seconds) convection reflow processes and is rated MSL1 per J-STD-020. The suggested solder reflow diagram is provided on the datasheet.

22. Is this product series RoHS compliant and Pb-free?

This product is RoHS compliant and Pb-free as defined in the [Ecliptek RoHS Compliant \(Pb-free\) Roadmap](#).

23. How can I obtain a RoHS compliant (Pb-free) certification for this product series?

A RoHS and Pb-free product certification letter can be obtained directly from our website by using the [Ecliptek RoHS/Pb-Free Certification Letter Generator](#).

24. Is an IPC-1752 material declaration available for customer review?

Ecliptek can provide a [Material Declaration](#) in compliance with IPC-1752 to assist customers with their material compliance requirements.

25. How do I layout my printed circuit board for this product series?

A suggested solder pad layout is provided on the datasheet. The customer should layout their PCB to include proper connections for the tri-state or power down input control function.

26. Who do I contact if I have additional technical questions about the use of this product series?

The [Global Customer Support](#) team at Ecliptek can provide applications engineering support or answer customer technical questions.

27. How do I order an oscillator that has custom requirements not specified on the standard oscillator series specification sheet?

Please contact the Ecliptek [Global Customer Support](#) team for additional support or questions regarding your oscillator requirements.

28. What are the environmental and mechanical specifications for this product series?

The environmental and mechanical specifications for this product series are listed on the series data sheet.

29. What reliability information is available for this product series?

Failure in Time (FIT) and Mean Time to Failure (MTTF) reliability data is available for this product series within the product series qualification and reliability report found on the series home page.

30. Is thermal resistance information available for this product series?

θ_{JA} and θ_{JC} values are available for this product series and can be found on the Environmental / Mechanical section of the series homepage.

31. Are IBIS models available for this product series?

Input/Output Buffer Information Specification (IBIS) modeling information can be found on the series home page.

32. What is the marking scheme for this product series?

As shown on the datasheet, this series of product has marking content on the top of the part. This marking consists of a pad one locator dot and additional alpha numeric marking. The marking represents an Ecliptek manufacturing designator. This designator is used internally at Ecliptek for manufacturing lot traceability. This manufacturing designator provides no indication of part number or date code or output frequency. The datasheet provides the marking content.

33. Can I identify the Ecliptek part number or specifications based upon the markings on top of the part?

In order to protect our customer's intellectual property, the Ecliptek part marking does not identify the Ecliptek part number or specifications.

34. Where can I get the information regarding discontinued or End of Life (EOL) products?

Any Ecliptek part number currently under an End of Life statement will be identified as EOL on an Ecliptek quotation, along with a link to the EOL statement. This information can also be found on the [End of Life Statements for Discontinued and Obsolete Products](#) section of our website.

35. Is Ecliptek ISO 9000 Certified?

Yes, Ecliptek is certified to [ISO 9001](#).

36. How can I obtain a REACH compliance statement for this product series?

A Registration, Evaluation, Authorization, and Restriction of Chemicals (REACH) compliance statement can be obtained directly from our website by using the [Ecliptek REACH Compliance Resources](#) page of our website.

37. How can I obtain an EICC-GeSI Conflict Minerals compliance template for this product series?

An Ecliptek Conflict Minerals Report based on the Electronic Industry Citizenship Coalition (EICC) and Global e-Sustainability Initiative (GeSI) Conflict-Free Smelter Program can be obtained directly from our website by using the [Ecliptek Conflict Minerals Resources](#) page. Navigate to our [Part Search](#) and drill down to a specific part number. The Part Number Detail page will contain a Conflict Mineral Report link. Clicking on this link will display the Conflict Mineral Report for that part number in PDF format.