

**EHF1145TTS-25.175M**
[Click part number to visit Part Number Details page](#)
**REGULATORY COMPLIANCE** (Data Sheet downloaded on Apr 6, 2020)
[Click badges to download compliance docs](#)

Regulatory Compliance standards are subject to updates by governing bodies. Click the badges to download the latest compliance docs for this part number directly from Ecliptek.

**ITEM DESCRIPTION**

Quartz Crystal Clock Oscillators XO (SPXO) HCMOS/TTL (CMOS) 5.0Vdc 14 Pin DIP Metal Thru-Hole 25.175MHz  $\pm$ 50ppm 0°C to +70°C

**ELECTRICAL SPECIFICATIONS**

<b>Nominal Frequency</b>	25.175MHz
<b>Frequency Tolerance/Stability</b>	$\pm$ 50ppm Maximum (Inclusive of all conditions: Calibration Tolerance at 25°C, Frequency Stability over the Operation Temperature Range, Supply Voltage Change, Output Load Change, First Year Aging at 25°C, Shock, and Vibration.)
<b>Aging at 25°C</b>	$\pm$ 5ppm/year Maximum
<b>Operating Temperature Range</b>	0°C to +70°C
<b>Supply Voltage</b>	5.0Vdc $\pm$ 10%
<b>Input Current</b>	50mA Maximum (No Load)
<b>Output Voltage Logic High (Voh)</b>	2.4Vdc Minimum with TTL Load, Vdd-0.4Vdc Minimum with HCMOS Load (IOH = -16mA)
<b>Output Voltage Logic Low (Vol)</b>	0.4Vdc Maximum with TTL Load, 0.5Vdc Maximum with HCMOS Load (IOL = +16mA)
<b>Rise/Fall Time</b>	6nSec Maximum (Measured at 0.8Vdc to 2.0Vdc with TTL Load, Measured at 20% to 80% of waveform with HCMOS Load)
<b>Duty Cycle</b>	50 $\pm$ 5(%) (Measured at 50% of waveform with TTL Load or with HCMOS Load)
<b>Load Drive Capability</b>	10TTL Load or 50pF HCMOS Load Maximum
<b>Output Logic Type</b>	CMOS
<b>Pin 1 Connection</b>	Tri-State (Disabled Output: High Impedance)
<b>Tri-State Input Voltage (Vih and Vil)</b>	+2.2Vdc Minimum to enable output, +0.8Vdc Maximum to disable output (High Impedance), No Connect to enable output.
<b>Absolute Clock Jitter</b>	$\pm$ 250pSec Maximum, $\pm$ 100pSec Typical
<b>One Sigma Clock Period Jitter</b>	$\pm$ 50pSec Maximum, $\pm$ 30pSec Typical
<b>Start Up Time</b>	10mSec Maximum
<b>Storage Temperature Range</b>	-55°C to +125°C

**ENVIRONMENTAL & MECHANICAL SPECIFICATIONS**

<b>Fine Leak Test</b>	MIL-STD-883, Method 1014, Condition A
<b>Gross Leak Test</b>	MIL-STD-883, Method 1014, Condition C
<b>Lead Integrity</b>	MIL-STD-883, Method 2004
<b>Mechanical Shock</b>	MIL-STD-202, Method 213, Condition C
<b>Resistance to Soldering Heat</b>	MIL-STD-202, Method 210
<b>Resistance to Solvents</b>	MIL-STD-202, Method 215
<b>Solderability</b>	MIL-STD-883, Method 2003
<b>Temperature Cycling</b>	MIL-STD-883, Method 1010
<b>Vibration</b>	MIL-STD-883, Method 2007, Condition A

# EHF1145TTS-25.175M

[Click part number to visit Part Number Details page](#)

## MECHANICAL DIMENSIONS (all dimensions in millimeters)

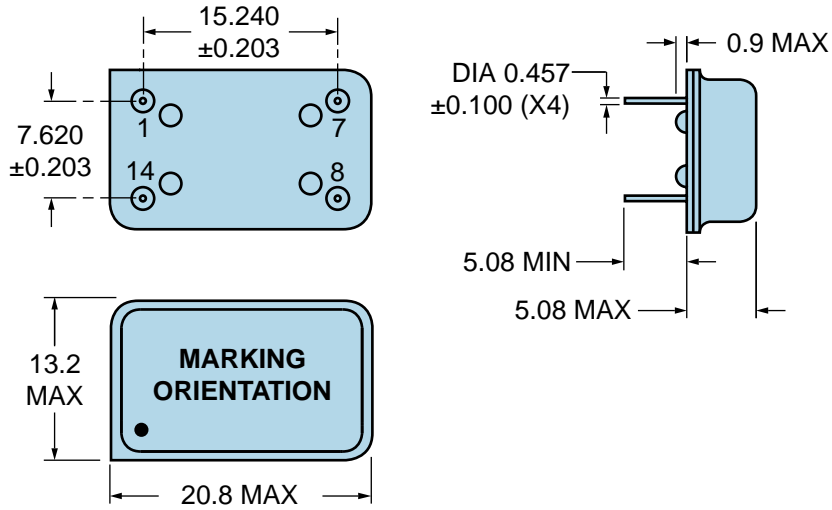

PIN	CONNECTION
1	Tri-State (High Impedance)
7	Ground/Case Ground
8	Output
14	Supply Voltage

LINE	MARKING
1	<b>ECLIPTEK</b>
2	<b>25.175M</b>
3	<b>XXXXX</b> XXXXX=Ecliptek Manufacturing Identifier

# EHF1145TTS-25.175M [Click part number to visit Part Number Details page](#)

## OUTPUT WAVEFORM & TIMING DIAGRAM

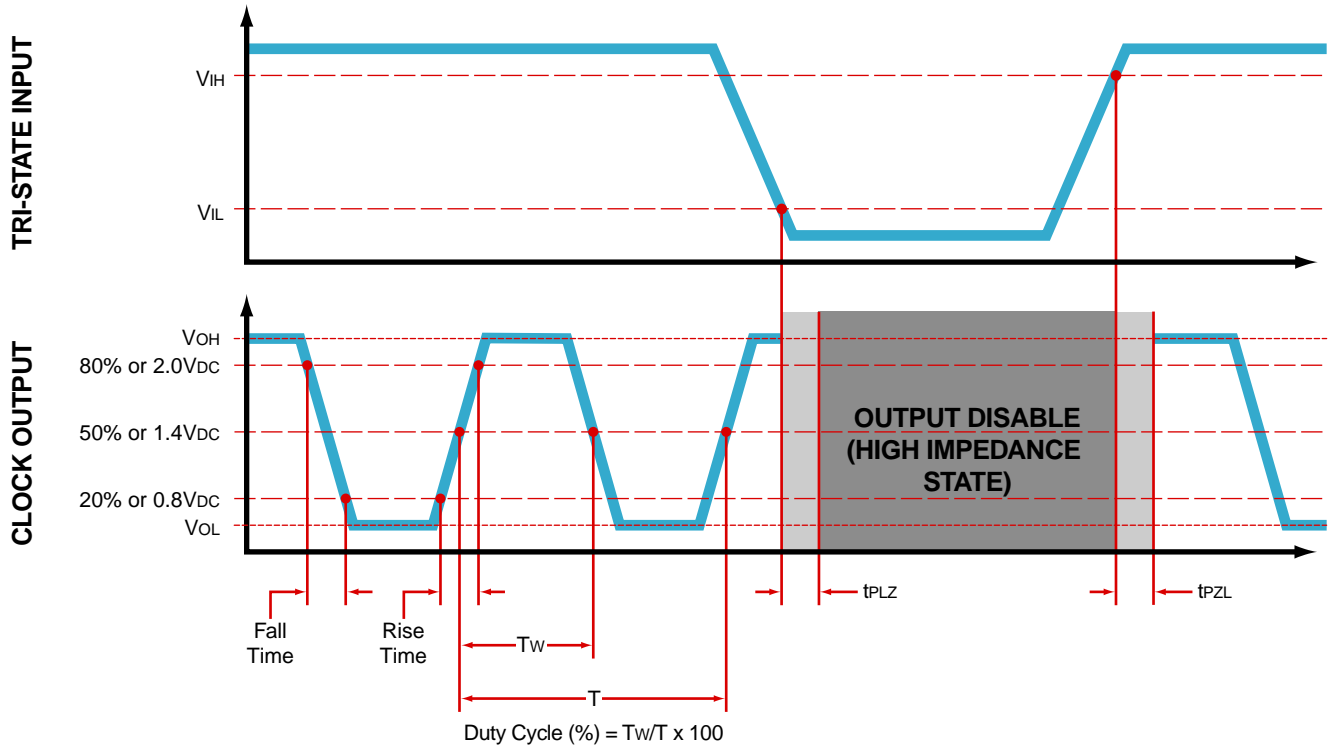

# EHF1145TTS-25.175M

[Click part number to visit Part Number Details page](#)

## Test Circuit for CMOS Output



Note 1: An external 0.01µF ceramic bypass capacitor in parallel with a 0.1µF high frequency ceramic bypass capacitor close (less than 2mm) to the package ground and supply voltage pin is required.

Note 2: A low capacitance (<12pF), 10X attenuation factor, high impedance (>10Mohms), and high bandwidth (>300MHz) passive probe is recommended.

Note 3: Capacitance value  $C_L$  includes sum of all probe and fixture capacitance.

# EHF1145TTS-25.175M

[Click part number to visit Part Number Details page](#)

## Test Circuit for TTL Output

Output Load Drive Capability	$R_L$ Value (Ohms)	$C_L$ Value (pF)
10TTL	390	15
5TTL	780	15

Table 1:  $R_L$  Resistance Value and  $C_L$  Capacitance Value Vs. Output Load Drive Capability

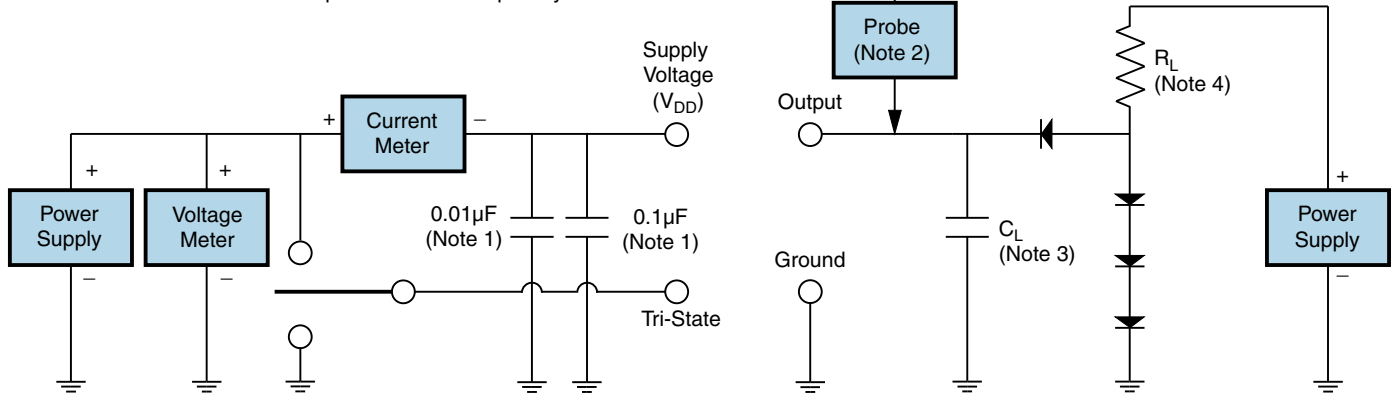

Note 1: An external 0.01µF ceramic bypass capacitor in parallel with a 0.1µF high frequency ceramic bypass capacitor close (less than 2mm) to the package ground and supply voltage pin is required.

Note 2: A low capacitance (<12pF), 10X attenuation factor, high impedance (>10Mohms), and high bandwidth (>300MHz) passive probe is recommended.

Note 3: Capacitance value  $C_L$  includes sum of all probe and fixture capacitance.

Note 4: Resistance value  $R_L$  is shown in Table 1. See applicable specification sheet for 'Load Drive Capability'.

Note 5: All diodes are MMBD7000, MMBD914, or equivalent.

# EHF1145TTS-25.175M

[Click part number to visit Part Number Details page](#)

## Recommended Solder Reflow Methods



### High Temperature Solder Bath (Wave Solder)

<b>Ts MAX to Tl (Ramp-up Rate)</b>	3°C/Second Maximum
<b>Preheat</b>	
- Temperature Minimum (Ts MIN)	150°C
- Temperature Typical (Ts TYP)	175°C
- Temperature Maximum (Ts MAX)	200°C
- Time (ts MIN)	60 - 180 Seconds
<b>Ramp-up Rate (Tl to Tp)</b>	3°C/Second Maximum
<b>Time Maintained Above:</b>	
- Temperature (Tl)	217°C
- Time (tL)	60 - 150 Seconds
<b>Peak Temperature (Tp)</b>	260°C Maximum for 10 Seconds Maximum
<b>Target Peak Temperature (Tp Target)</b>	250°C +0/-5°C
<b>Time within 5°C of actual peak (tp)</b>	20 - 40 Seconds
<b>Ramp-down Rate</b>	6°C/Second Maximum
<b>Time 25°C to Peak Temperature (t)</b>	8 Minutes Maximum
<b>Moisture Sensitivity Level</b>	Level 1
<b>Additional Notes</b>	Temperatures shown are applied to back of PCB board and device leads only. Do not use this method for product with the Gull Wing option.

# EHF1145TTS-25.175M

[Click part number to visit Part Number Details page](#)

## Recommended Solder Reflow Methods



### Low Temperature Infrared/Convection 185°C

<b><math>T_s</math> MAX to <math>T_L</math> (Ramp-up Rate)</b>	5°C/Second Maximum
<b>Preheat</b>	
- Temperature Minimum ( $T_s$ MIN)	N/A
- Temperature Typical ( $T_s$ TYP)	150°C
- Temperature Maximum ( $T_s$ MAX)	N/A
- Time ( $t_s$ MIN)	60 - 120 Seconds
<b>Ramp-up Rate (<math>T_L</math> to <math>T_P</math>)</b>	5°C/Second Maximum
<b>Time Maintained Above:</b>	
- Temperature ( $T_L$ )	150°C
- Time ( $t_L$ )	200 Seconds Maximum
<b>Peak Temperature (<math>T_P</math>)</b>	185°C Maximum
<b>Target Peak Temperature (<math>T_P</math> Target)</b>	185°C Maximum 2 Times
<b>Time within 5°C of actual peak (<math>t_p</math>)</b>	10 Seconds Maximum 2 Times
<b>Ramp-down Rate</b>	5°C/Second Maximum
<b>Time 25°C to Peak Temperature (t)</b>	N/A
<b>Moisture Sensitivity Level</b>	Level 1
<b>Additional Notes</b>	Temperatures shown are applied to body of device. Use this method only for product with the Gull Wing option.

# EHF1145TTS-25.175M

[Click part number to visit Part Number Details page](#)

## Recommended Solder Reflow Methods



### Low Temperature Solder Bath (Wave Solder)

$T_s$ MAX to $T_L$ (Ramp-up Rate)	5°C/Second Maximum
<b>Preheat</b>	
- Temperature Minimum ( $T_s$ MIN)	N/A
- Temperature Typical ( $T_s$ TYP)	150°C
- Temperature Maximum ( $T_s$ MAX)	N/A
- Time ( $t_s$ MIN)	30 - 60 Seconds
<b>Ramp-up Rate (<math>T_L</math> to <math>T_P</math>)</b>	5°C/Second Maximum
<b>Time Maintained Above:</b>	
- Temperature ( $T_L$ )	150°C
- Time ( $t_L$ )	200 Seconds Maximum
<b>Peak Temperature (<math>T_P</math>)</b>	245°C Maximum
<b>Target Peak Temperature (<math>T_P</math> Target)</b>	245°C Maximum 1 Time / 235°C Maximum 2 Times
<b>Time within 5°C of actual peak (<math>t_p</math>)</b>	5 Seconds Maximum 1 Time / 15 Seconds Maximum 2 Times
<b>Ramp-down Rate</b>	5°C/Second Maximum
<b>Time 25°C to Peak Temperature (t)</b>	N/A
<b>Moisture Sensitivity Level</b>	Level 1
<b>Additional Notes</b>	Temperatures shown are applied to back of PCB board and device leads only. Do not use this method for product with the Gull Wing option.

### Low Temperature Manual Soldering

185°C Maximum for 10 Seconds Maximum, 2 times Maximum. (Temperatures listed are applied to device leads only. This method can be utilized with both Gull Wing and Non-Gull Wing devices.)

### High Temperature Manual Soldering

260°C Maximum for 5 Seconds Maximum, 2 times Maximum. (Temperatures listed are applied to device leads only. This method can be utilized with both Gull Wing and Non-Gull Wing devices.)