

EQUJ32D5F1H-20.910M

[Click part number to visit Part Number Details page](#)

REGULATORY COMPLIANCE (Data Sheet downloaded on Apr 6, 2020)

[Click badges to download compliance docs](#)

Regulatory Compliance standards are subject to updates by governing bodies. Click the badges to download the latest compliance docs for this part number directly from Ecliptek.



ITEM DESCRIPTION

Temperature Compensated Voltage Controlled Quartz Crystal Clock Oscillators TCVCXO LVDS (DS) 2.5Vdc 6 Pad 2.5mm x 3.2mm Ceramic Surface Mount (SMD) 20.910MHz -30°C to +60°C

ELECTRICAL SPECIFICATIONS

Nominal Frequency	20.910MHz
Frequency Stability	±2.5ppm Maximum (Inclusive of Operating Temperature Range, at Vdd=2.5Vdc, at Vc=1.5Vdc)
Frequency Stability vs. Frequency Tolerance	±1.5ppm Maximum (at 25°C ±2°C, at Vdd=2.5Vdc, at Vc=1.5Vdc ±0.1Vdc, Pre-Reflow)
Frequency Stability vs. Input Voltage	±0.2ppm Maximum (±5%)
Frequency Stability vs. Load	±0.2ppm Maximum (±2pF)
Frequency Stability vs. Reflow	±1.0ppm Maximum (at 25°C, 24 hours after reflow, 1 time)
Frequency Stability vs. Aging	±1ppm/Year Maximum (at 25°C)
Operating Temperature Range	-30°C to +60°C
Supply Voltage	2.5Vdc ±5%
Input Current	25mA Maximum (Unloaded)
Output Voltage Logic High (Voh)	1.425Vdc Typical
Output Voltage Logic Low (Vol)	1.075Vdc Typical
Differential Output Error (dVod)	50mVdc Maximum
Differential Output Voltage (Vod)	200mVdc Minimum, 350mVdc Typical, 454mVdc Maximum
Offset Voltage (Vos)	1.125Vdc Minimum, 1.250Vdc Typical, 1.375Vdc Maximum
Rise/Fall Time	500pSec Maximum (Measured at 10% to 90% of Waveform)
Duty Cycle	50 ±5(%) (Measured at 50% of Waveform)
Offset Error (dVos)	50mVdc Maximum
Load Drive Capability	100 Ohms Between Output and Complementary Output
Output Logic Type	LVDS
Control Voltage	1.5Vdc ±1.0Vdc
Frequency Deviation	±8ppm Minimum
Linearity	10% Maximum
Transfer Function	Positive Transfer Characteristic
Modulation Bandwidth	10kHz Minimum (Measured at -3dB)
Input Impedance	1MOhms Minimum
Phase Noise	-64dBc/Hz at 10Hz offset; -96dBc/Hz at 100Hz offset; -124dBc/Hz at 1kHz offset; -131dBc/Hz at 10kHz offset; -132dBc/Hz at 100kHz offset; -149dBc/Hz at 1MHz offset; -157dBc/Hz at 10MHz offset; -159dBc/Hz at 20MHz offset (All Values are Typical)
Output Control Function	Output Enable (OE)
Output Control Input Voltage Logic High (Vih)	90% of Vdd Minimum or No Connect to Enable Output and Complementary Output
Output Control Input Voltage Logic Low (Vil)	10% of Vdd Maximum to Disable Output and Complementary Output (High Impedance)
Output Enable Time	100nSec Maximum
Output Disable Time	50nSec Maximum
Output Enable Current	15mA Maximum (Without Load (Pin 2 = Ground))
RMS Phase Jitter	1.5pSec Maximum (Fj=12kHz to 20MHz (Random))

EQUJ32D5F1H-20.910M
[Click part number to visit Part Number Details page](#)
ELECTRICAL SPECIFICATIONS CONTINUED

Period Jitter (Deterministic)	0.2pSec Typical
Period Jitter (Random)	2pSec Typical
Period Jitter (RMS)	3pSec Maximum
Period Jitter (pk-pk)	30pSec Maximum
Start Up Time	10mSec Maximum
Storage Temperature Range	-55°C to +125°C

ENVIRONMENTAL & MECHANICAL SPECIFICATIONS

ESD Susceptibility	MIL-STD-883, Method 3015, Class 1, HBM: 1500V
Fine Leak Test	MIL-STD-883, Method 1014, Condition A
Flammability	UL94-V0
Gross Leak Test	MIL-STD-883, Method 1014, Condition C
Mechanical Shock	MIL-STD-883, Method 2002, Condition B
Moisture Resistance	MIL-STD-883, Method 1004
Moisture Sensitivity	J-STD-020, MSL 1
Resistance to Soldering Heat	MIL-STD-202, Method 210, Condition K
Resistance to Solvents	MIL-STD-202, Method 215
Solderability	MIL-STD-883, Method 2003
Temperature Cycling	MIL-STD-883, Method 1010, Condition B
Vibration	MIL-STD-883, Method 2007, Condition A

EQUJ32D5F1H-20.910M [Click part number to visit Part Number Details page](#)

MECHANICAL DIMENSIONS (all dimensions in millimeters)



PIN	CONNECTION
1	Control Voltage
2	Output Enable (OE)
3	Case/Ground
4	Output
5	Complementary Output
6	Supply Voltage

LINE	MARKING
1	E20.910 E=Ecliptek Designator
2	XXXXX XXXXX=Ecliptek Manufacturing Identifier

Terminal Plating Thickness: Gold (0.3 to 1.0µm) over Nickel (1.27 to 8.89µm).

Suggested Solder Pad Layout

All Dimensions in Millimeters



All Tolerances are ±0.1

EQUJ32D5F1H-20.910M [Click part number to visit Part Number Details page](#)

OUTPUT WAVEFORM & TIMING DIAGRAM

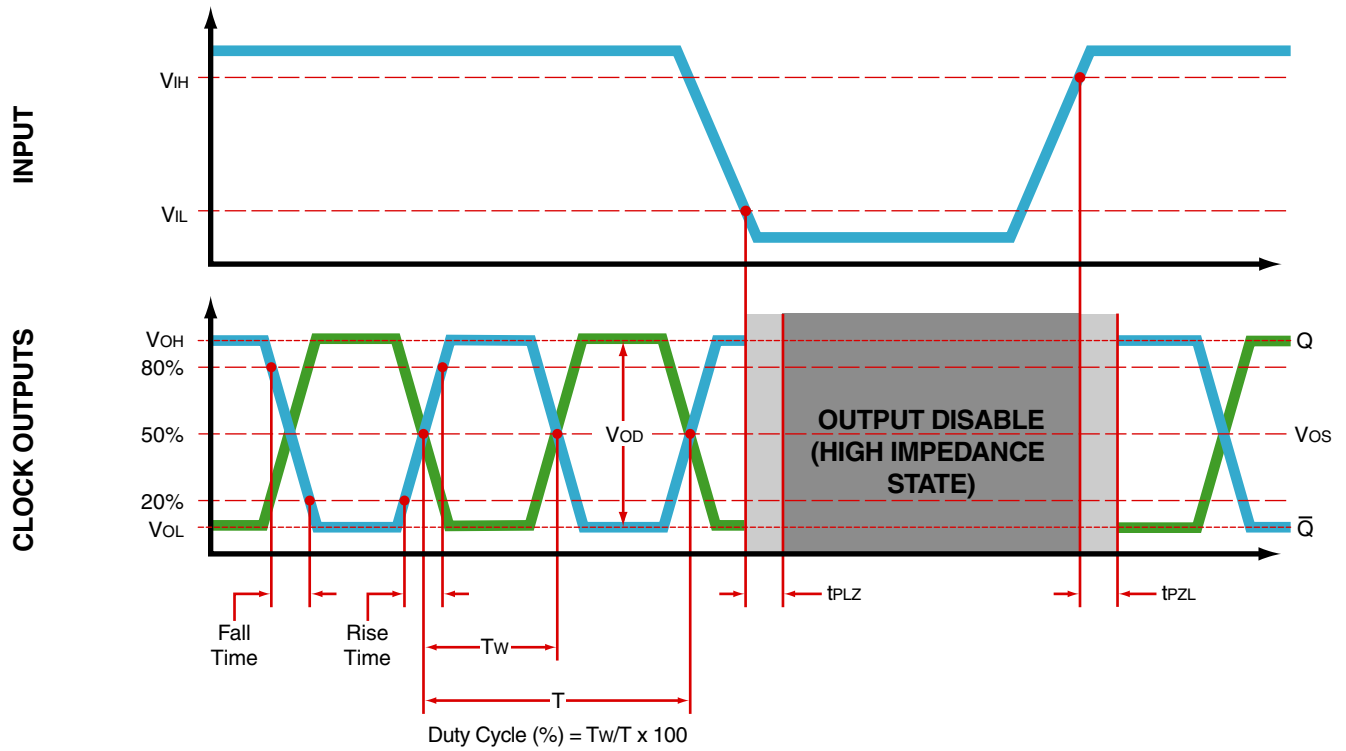

EQUJ32D5F1H-20.910M

[Click part number to visit Part Number Details page](#)

Test Circuit for LVDS Output

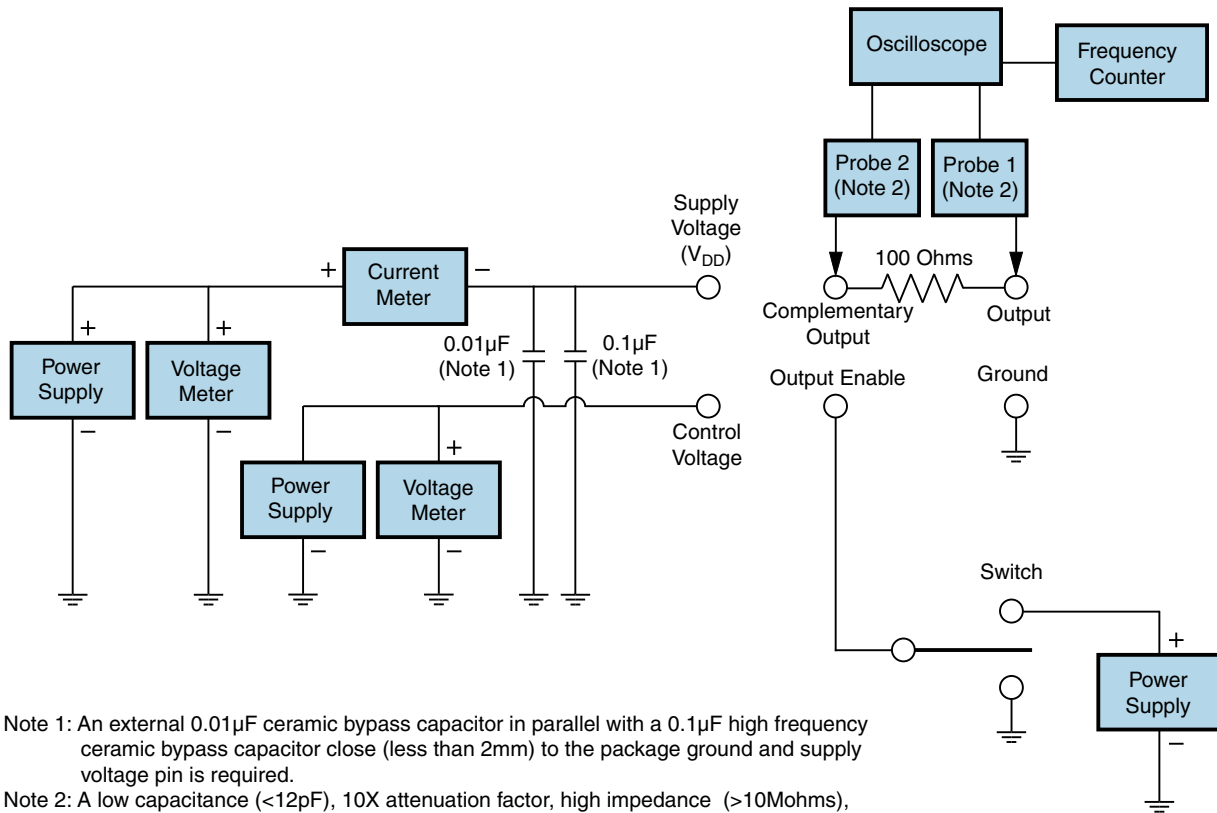

Note 1: An external 0.01 μF ceramic bypass capacitor in parallel with a 0.1 μF high frequency ceramic bypass capacitor close (less than 2mm) to the package ground and supply voltage pin is required.

Note 2: A low capacitance (<12pF), 10X attenuation factor, high impedance (>10Mohms), and high bandwidth (>500MHz) passive probe is recommended.

Note 3: Test circuit PCB traces need to be designed for a characteristic line impedance of 50 ohms.

EQUJ32D5F1H-20.910M

[Click part number to visit Part Number Details page](#)

Recommended Solder Reflow Methods



High Temperature Infrared/Convection

$T_s \text{ MAX}$ to T_L (Ramp-up Rate)	3°C/Second Maximum
Preheat	
- Temperature Minimum ($T_s \text{ MIN}$)	150°C
- Temperature Typical ($T_s \text{ TYP}$)	175°C
- Temperature Maximum ($T_s \text{ MAX}$)	200°C
- Time ($t_s \text{ MIN}$)	60 - 180 Seconds
Ramp-up Rate (T_L to T_P)	3°C/Second Maximum
Time Maintained Above:	
- Temperature (T_L)	217°C
- Time (t_L)	60 - 150 Seconds
Peak Temperature (T_P)	260°C Maximum for 10 Seconds Maximum
Target Peak Temperature ($T_P \text{ Target}$)	250°C +0/-5°C
Time within 5°C of actual peak (t_p)	20 - 40 Seconds
Ramp-down Rate	6°C/Second Maximum
Time 25°C to Peak Temperature (t)	8 Minutes Maximum
Moisture Sensitivity Level	Level 1
Additional Notes	Temperatures shown are applied to body of device.

EQUJ32D5F1H-20.910M

[Click part number to visit Part Number Details page](#)

Recommended Solder Reflow Methods



Low Temperature Infrared/Convection 240°C

T_s MAX to T_L (Ramp-up Rate)	5°C/Second Maximum
Preheat	
- Temperature Minimum (T_s MIN)	N/A
- Temperature Typical (T_s TYP)	150°C
- Temperature Maximum (T_s MAX)	N/A
- Time (t_s MIN)	60 - 120 Seconds
Ramp-up Rate (T_L to T_P)	5°C/Second Maximum
Time Maintained Above:	
- Temperature (T_L)	150°C
- Time (t_L)	200 Seconds Maximum
Peak Temperature (T_P)	240°C Maximum
Target Peak Temperature (T_P Target)	240°C Maximum 2 Times / 230°C Maximum 1 Time
Time within 5°C of actual peak (t_p)	10 Seconds Maximum 2 Times / 80 Seconds Maximum 1 Time
Ramp-down Rate	5°C/Second Maximum
Time 25°C to Peak Temperature (t)	N/A
Moisture Sensitivity Level	Level 1
Additional Notes	Temperatures shown are applied to body of device.

Low Temperature Manual Soldering

185°C Maximum for 10 Seconds Maximum, 2 times Maximum. (Temperatures shown are applied to body of device.)

High Temperature Manual Soldering

260°C Maximum for 5 Seconds Maximum, 2 times Maximum. (Temperatures shown are applied to body of device.)